



# ALL-NEW 2023 COLORADO

*The safari bar may block the front camera view or limit the camera's field of view, which will inhibit the HD Surround Vision system. Always check around the vehicle before driving or parking.*

# Made for more.

The All-New 2023 Colorado is for those who embrace everything life throws their way and still strive for more.

More adventure. More memories. More out of every day and every moment. That's why we reimagined it with an engine series that's capable on so many levels, along with a trio of off-road models ready to tame nearly any trail.

The reconfigurable bed in Colorado offers a first-in-class<sup>1</sup> StowFlex Tailgate, while two segment-first available underbody cameras<sup>2</sup> provide real-time forward- and rear-facing views beneath the truck.

Add in a redesigned and highly refined interior loaded with the latest tech, and you aren't just ready to do more. You're ready to be more.



Colorado ZR2 in Glacier Blue Metallic (extra-cost color) with available Desert Boss Special Edition.

## At a glance.

- Five models: WT, LT, Z71, Trail Boss and ZR2
- Crew Cab Short Box
- Z71, Trail Boss and ZR2 4x4 only; WT and LT 2WD or 4x4
- 2.7L Turbo engine with three available outputs
  - 2.7L Turbo with 237 horsepower and 260 lb.-ft. of torque
  - 2.7L Turbo Plus with 310 horsepower and 391 lb.-ft. of torque
  - 2.7L Turbo High-Output with 310 horsepower and 430 lb.-ft. of torque
- New 8-speed automatic transmission on all models
- Up to a best-in-class 7,700 lbs. maximum trailering weight<sup>1</sup> with available 2.7L Turbo Plus engine
- 1,710 lbs. maximum payload<sup>2</sup>
- CornerStep rear bumper (excludes ZR2)
- Wireless Apple CarPlay<sup>®3</sup> and wireless Android Auto<sup>™4</sup> compatibility



Colorado Z71 in Sterling Gray Metallic with available features.



Colorado Trail Boss in Radiant Red Tintcoat (extra-cost color).

<sup>1</sup> Based on latest available competitive data. Requires Colorado with available 2.7L Turbo Plus engine and Advanced Trailering Package. Maximum trailering ratings are intended for comparison purposes only. Before you buy a vehicle or use it for trailering, carefully review the Trailering section of the Owner's Manual. The trailering capacity of your specific vehicle may vary. The weight of passengers, cargo and options or accessories may reduce the amount you can trailer. <sup>2</sup> Requires Colorado WT with available 2.7L Turbo Plus engine. For comparison purposes only. See the Owner's Manual and the label on the vehicle door jamb for the carrying capacity of a specific vehicle. <sup>3</sup> Vehicle user interface is a product of Apple, and its terms and privacy statements apply. Requires compatible iPhone, and data plan rates apply. <sup>4</sup> Vehicle user interface is a product of Google, and its terms and privacy statements apply. Requires the Android Auto app on Google Play and a compatible Android smartphone. Data plan rates apply. You can check which smartphones are compatible at [g.co/androidauto/requirements](https://g.co/androidauto/requirements).

Apple CarPlay is a trademark of Apple Inc. Siri, iPhone and iTunes are trademarks of Apple Inc., registered in the U.S. and other countries. Android Auto is a trademark of Google LLC.

## What's new: Overview.

- The first-ever Colorado Trail Boss. Learn about our expanded off-road lineup on page 7
- Fully redesigned interior includes
  - Four distinct interiors with model-specific colors, finishes and features
  - Class-leading<sup>1</sup> 11.3-inch diagonal color touch-screen display and Google built-in<sup>2</sup> compatibility
  - Segment-first<sup>1</sup> fully digital customizable Driver Information Center
- All-new bold exterior styling with rugged, athletic proportions and enhanced approach, breakover and departure angles
- Off-road performance display monitors 3D pitch and roll, altitude, g-force and more
- Chevy Safety Assist<sup>3</sup> is standard on all models and includes
  - Automatic Emergency Braking
  - Front Pedestrian and Bicyclist Braking
  - Lane Keep Assist with Lane Departure Warning
  - Forward Collision Alert
  - IntelliBeam<sup>®</sup>
  - Following Distance Indicator (functionality requires a late available software update; see dealer for details)
- Available StowFlex Tailgate. See page 5 for details
- Up to a class-leading<sup>1</sup> 10 available camera views<sup>3</sup>, including segment-first underbody cameras with front and rear views. See page 6 for details
- Available Advanced Trailering Package with Trailering App.<sup>4</sup> See page 9 for details
- Up to five drive modes to optimize performance: Normal, Tow/Haul, Terrain, Off-Road and Baja (ZR2 only)



Colorado Z71 interior in Jet Black with Adrenaline Red accents and available features.

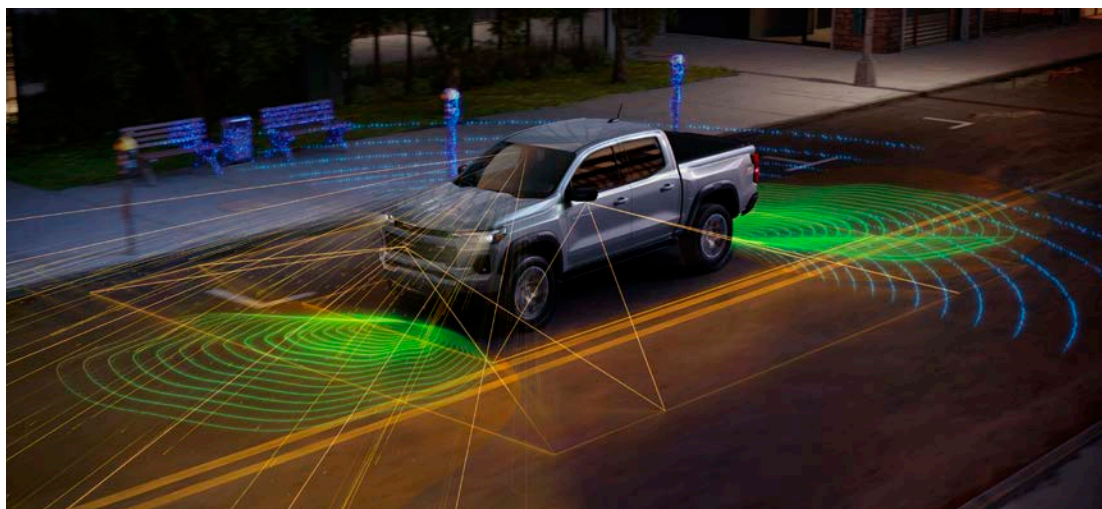

Standard Chevy Safety Assist<sup>3</sup> and available advanced safety features.<sup>3</sup>

<sup>1</sup> Based on latest available competitive data. <sup>2</sup> Google built-in services are subject to limitations and availability may vary by vehicle, infotainment system and location. Select service plan required. Certain Google actions and functionality may require account linking. User terms and privacy statements apply. Google, Google Play and Google Maps are trademarks of Google LLC. <sup>3</sup> Safety or driver assistance features are no substitute for the driver's responsibility to operate the vehicle in a safe manner. Read the vehicle Owner's Manual for important feature limitations and information. <sup>4</sup> App functionality and features vary with vehicle equipment and trim level. Data connection may be required. Some features require active service plan and working electrical system. User terms and limitations apply.

## What's new: StowFlex Tailgate.

An available first-in-class<sup>1</sup> StowFlex Tailgate gives you a lockable storage compartment built into the tailgate that's perfect for stowing tools or emergency equipment, and it even includes a drain so it can be used as a cooler.

- Additional pickup bed functionality includes
  - Eight standard fixed tie-downs
  - Up to nine available tie-downs for a total of 17 tie-downs
  - Available touch-enabled in-bed lighting
  - Built-in motorcycle tire grooves
  - Three-tier loading
  - 10 bed pockets and 4 stake pockets
  - Available 120-volt outlet
  - Available mid-position tailgate opening with 500 lbs. capacity<sup>2</sup>
  - Available reconfigurable bed rail system
  - Measurement tool integrated into the tailgate



Available StowFlex Tailgate.

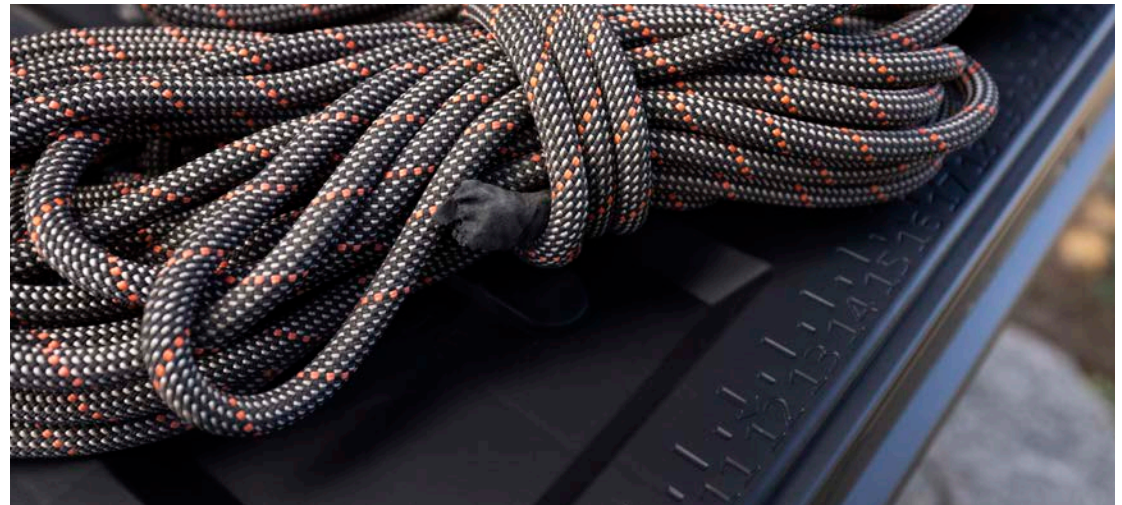

Molded-in measurement tool.

<sup>1</sup> Based on latest available competitive data. <sup>2</sup> These maximum payload ratings are intended for comparison purposes only. Before you buy a vehicle or use it to haul people or cargo, carefully review the Vehicle Loading section of the Owner's Manual and check the carrying capacity of your specific vehicle on the label on the inside of the driver door jamb. A 500-lb. capacity will require two (2-inch x 8-inch) boards that must be cut to fit snugly into the slots on either side of the truck bed.

## What's new: Camera tech.

Colorado offers a best-in-class<sup>1</sup> 10 available camera views<sup>2</sup> to help you hit the open road with confidence. And thanks to the segment-first available underbody cameras offering real-time forward- and rear-facing views beneath the truck, you can navigate rocky trails and other difficult terrain.

- Two available hitch views
  - Hitch View
  - Surround View
- One available driving view
  - Front Grille View
- Five available parking views
  - Rear Camera View
  - Front Top-Down View
  - Rear Top-Down View
  - Front Side View
  - Rear Side View
- Two available off-road performance views
  - Front Underbody View
  - Rear Underbody View



Rear Underbody View.



Rear Camera View?

## Off-road lineup.

### Z71 — capability and adventure begin here

- 2.7L Turbo Plus engine: 310 horsepower and 391 lb.-ft. of torque
- 18-inch wheels with all-terrain tires
- Jet Black interior with Adrenaline Red accents
- Four selectable drive modes and off-road performance display
- 2-speed Autotrac® transfer case and transfer case shield

### Trail Boss — a step up in all-terrain ability

In addition to or replacing Z71 features, Trail Boss includes

- 2-inch factory-installed lift
- Wider chassis
- Black wheel moldings
- Jet Black interior

### ZR2 — the ultimate off-road Colorado

In addition to or replacing Trail Boss or Z71 features, ZR2 includes

- 2.7L Turbo High-Output engine: 310 horsepower and 430 lb.-ft. of torque
- 17-inch wheels with 33-inch MT tires
- 3-inch factory-installed lift with high-performance suspension and wider chassis
- Segment-exclusive<sup>1</sup> Multimatic DSSV™ dampers
- Five selectable drive modes
- Rocker panel protector and aluminum performance skid plate
- Exclusive Artemis interior with Strike Yellow accents
- Driver-selectable electronic locking front and rear differentials
- Flowtie badge and Black hood appliqué



The Colorado off-road lineup.



Colorado ZR2 in Glacier Blue Metallic (extra-cost color) with available features.

<sup>1</sup>Based on latest available competitive data.

## Desert Boss Special Edition.

When “dominate every dune” is at the top of your to-do list, Colorado ZR2 with the new Desert Boss Special Edition is your ride. In addition to an off-road-ready résumé that includes the 2.7L Turbo High-Output engine, a 3-inch factory-installed lift with high-performance suspension and Multimatic DSSV™ dampers, the Desert Boss Special Edition contains everything you need to conquer new roads ... or no roads at all.

- Off-road front bumper with safari bar
- Bed-mounted sport bar with ZR2 sail panel
- 40-inch roof off-road light bar
- 17-inch beadlock-capable wheels
- Underbody cameras<sup>1</sup>
- Front Fender Decal Package
- Bodyside Decal Package
- Tailgate Decal Package
- Rear side decal
- Black nameplates
- Auxiliary power box



The safari bar may block the front camera view or limit the camera's field of view, which will inhibit the HD Surround Vision system. Always check around the vehicle before driving or parking.

Colorado ZR2 in Glacier Blue Metallic (extra-cost color) with available Desert Boss Special Edition.



Colorado ZR2 in Glacier Blue Metallic (extra-cost color) with available Desert Boss Special Edition.

<sup>1</sup> Safety or driver assistance features are no substitute for the driver's responsibility to operate the vehicle in a safe manner. Read the vehicle Owner's Manual for important feature limitations and information.



## Trailering technology.

You may know that Colorado offers up to a best-in-class 7,700 lbs. maximum trailering weight.<sup>1</sup> But our midsize pickup also provides features such as Hitch Guidance<sup>2</sup> and Hitch View,<sup>2</sup> along with other standard and available trailering technology designed to make short work out of a long day of towing.

Available Advanced Trailering Package includes

- Trailering Package with heavy-duty trailer hitch
- 7-pin connector
- Integrated trailer brake controller
- Auto-locking rear differential included on WT and LT
- Trailering App<sup>3</sup>

Available Trailering App<sup>3</sup> offers (may require additional optional equipment)

- Checklist<sup>4</sup>
- Trailer light sequencing
- Trailer maintenance reminders
- Trailer security alerts
- Trailer mileage
- Tow/Haul reminder
- Trailer electrical diagnostics



Colorado Z71 in Sterling Gray Metallic with available features.



In-vehicle Trailering App<sup>3</sup>

## Trailering Guide >

<sup>1</sup> Based on latest available competitive data. Requires Colorado with available 2.7L Turbo Plus engine and Advanced Trailering Package. Maximum trailering ratings are intended for comparison purposes only. Before you buy a vehicle or use it for trailering, carefully review the Trailering section of the Owner's Manual. The trailering capacity of your specific vehicle may vary. The weight of passengers, cargo and options or accessories may reduce the amount you can trailer. <sup>2</sup> Safety or driver assistance features are no substitute for the driver's responsibility to operate the vehicle in a safe manner. Read the vehicle Owner's Manual for important feature limitations and information. <sup>3</sup> App functionality and features vary with vehicle equipment and trim level. Data connection may be required. Some features require active service plan and working electrical system. User terms and limitations apply. <sup>4</sup> App functionality and features vary with vehicle equipment and trim level. Device data connection may be required. Available on select Apple and Android devices. Some features require connected vehicle services trial or active plan and working electrical system.

## Five models to choose from.



### WT

The midsize pickup that never quits.

- 2.7L Turbo engine with 237 horsepower and 260 lb.-ft. of torque
- 8-speed automatic transmission
- Eight fixed pickup bed tie-downs
- CornerStep rear bumper
- 17-inch Ultra Silver Metallic steel wheels
- Jet Black interior
- Durable interior materials
- 11.3-inch diagonal center touch-screen with Google built-in<sup>1</sup>
- 8-inch diagonal digital Driver Information Center
- Wireless Apple CarPlay<sup>®2</sup> and wireless Android Auto<sup>™3</sup> compatibility
- Remote Keyless Entry with Push-Button Start
- Chevy Safety Assist<sup>4</sup>



### LT

Classic looks. Completely comfortable.

- 17-inch Argent Metallic aluminum wheels with all-season tires
- Body-color front fascia, door handles and rear bumper
- Keyless Open and Start
- Remote locking tailgate
- Jet Black interior with Bright Silver accents
- Premium wrapped steering wheel
- Center console
- Power windows with driver express-up/-down
- Rear air vents
- Carpeted front and rear floor mats

<sup>1</sup> Google built-in services are subject to limitations and availability may vary by vehicle, infotainment system and location. Select service plan required. Certain Google actions and functionality may require account linking. User terms and privacy statements apply. Google, Google Play and Google Maps are trademarks of Google LLC. <sup>2</sup> Vehicle user interface is a product of Apple, and its terms and privacy statements apply. Requires compatible iPhone, and data plan rates apply. <sup>3</sup> Vehicle user interface is a product of Google, and its terms and privacy statements apply. Requires the Android Auto app on Google Play and a compatible Android smartphone. Data plan rates apply. You can check which smartphones are compatible at [g.co/androidauto/requirements](https://g.co/androidauto/requirements). <sup>4</sup> Chevy Safety Assist includes Automatic Emergency Braking, Front Pedestrian Braking, Lane Keep Assist with Lane Departure Warning, Forward Collision Alert, IntelliBeam and Following Distance Indicator. Safety or driver assistance features are no substitute for the driver's responsibility to operate the vehicle in a safe manner. Read the vehicle Owner's Manual for important feature limitations and information.



## Five models to choose from.



### Trail Boss

The truck to tame nearly any trail.

- 2.7L Turbo Plus engine with 310 horsepower and 391 lb.-ft. of torque
- 2-inch factory-installed lift and wider chassis
- 2-speed Autotrac transfer case and transfer case shield
- Automatic locking rear differential
- Four selectable drive modes (Off-Road, Terrain, Tow/Haul and Normal)
- Hill Descent Control
- 18-inch high-gloss Black aluminum wheels with all-terrain tires
- Full-size spare tire and wheel
- Black Chevrolet bowtie emblems
- Black wheel moldings
- Black recovery hooks<sup>1</sup>
- Off-road performance display



### Z71

Always ready for the next adventure.

- 2.7L Turbo Plus engine with 310 horsepower and 391 lb.-ft. of torque
- 18-inch Android dark full-gloss aluminum wheels with all-terrain tires
- Outside heated power-adjustable mirrors
- LED headlamps, taillamps and fog lamps
- Red recovery hooks<sup>1</sup>
- Jet Black interior with Adrenaline Red accents
- 120-volt power outlets on the rear of the center console and in the pickup bed (up to 400 watts shared)
- Sliding front visors with illuminated vanity mirrors
- Sliding rear window with electric defogger
- Two rear charge-only USB ports<sup>2</sup>
- Cruise control



### ZR2

The ultimate in off-road capability.

- 2.7L Turbo High-Output engine with 310 horsepower and 430 lb.-ft. of torque
- 3-inch factory-installed lift with high-performance suspension and ultra-wide stance
- Segment-exclusive<sup>3</sup> Multimatic DSSV™ dampers
- Electronic locking front and rear differentials
- Five selectable drive modes
- Rocker panel protector and aluminum performance skid plate
- Off-road front fascia and rear bumper
- 17-inch Graphite and Oxide Gold aluminum wheels with 33-inch MT tires
- StowFlex Tailgate
- Trailering Package with Trailering App<sup>4</sup>
- Flowtie badge and Black hood appliqué
- Artemis interior with Strike Yellow accents
- Heated front seats
- 11-inch diagonal digital Driver Information Center

Desert Boss Special Edition available

# Model availability

## CREW CAB SHORT BOX



● AVAILABLE – NOT AVAILABLE

TRIM	2WD	4x4	STANDARD ENGINE	AVAILABLE ENGINE	MAX PAYLOAD RATING (LBS.) <sup>1</sup>	MAX TRAILERING WEIGHT RATING (LBS.) <sup>2</sup>
WT	●	–	2.7L Turbo	2.7L Turbo Plus	1,710 <sup>3</sup>	7,700 <sup>3,4</sup>
WT	–	●	2.7L Turbo	2.7L Turbo Plus	1,710 <sup>3</sup>	7,700 <sup>3,4</sup>
LT	●	–	2.7L Turbo	2.7L Turbo Plus	1,680 <sup>3</sup>	7,700 <sup>3,4</sup>
LT	–	●	2.7L Turbo	2.7L Turbo Plus	1,670 <sup>3</sup>	7,700 <sup>3,4</sup>
Trail Boss	–	●	2.7L Turbo Plus	–	1,580	7,700 <sup>4</sup>
Z71	–	●	2.7L Turbo Plus	–	1,580	7,700 <sup>4</sup>
ZR2	–	●	2.7L Turbo High-Output	–	1,280	6,000

<sup>1</sup> These maximum payload ratings are intended for comparison purposes only. Before you buy a vehicle or use it to haul people or cargo, carefully review the Vehicle Loading section of the Owner's Manual and check the carrying capacity of your specific vehicle on the label on the inside of the driver door jamb. <sup>2</sup> Maximum trailering ratings are intended for comparison purposes only. Before you buy a vehicle or use it for trailering, carefully review the Trailering section of the Owner's Manual. The trailering capacity of your specific vehicle may vary. The weight of passengers, cargo and options or accessories may reduce the amount you can trailer. <sup>3</sup> Requires available 2.7L Turbo Plus engine. <sup>4</sup> Requires available Trailering Package or Advanced Trailering Package.

## Work Truck (WT)



Summit White



Sterling Gray Metallic



Sand Dune Metallic



Harvest Bronze Metallic



Radiant Red Tintcoat<sup>1</sup>



Glacier Blue Metallic<sup>1</sup>



Black

<sup>1</sup>Extra-cost color.

# Work Truck (WT)



In addition to [standard equipment](#), select WT features include:

## MECHANICAL

Engine – 2.7L Turbo and Automatic Stop/Start with disable switch

Transfer case – single-speed, electronic Autotrac with push-button control (4x4 models)

Transmission – 8-speed automatic, electronically controlled with overdrive

## EXTERIOR

Mirrors – power-adjustable, manual-folding with molded-in color Black caps

Recovery hooks<sup>1</sup> – Black (4x4 models)

Tires – 255/65R17 all-season

## INTERIOR

Air conditioning – manual, single-zone

Driver Information Center – 8-inch diagonal fully digital display

HD Rear Vision Camera<sup>2</sup>

Push-Button Start

Remote Keyless Entry

Seat – driver 6-way manual adjuster

Steering column – manual tilt

Steering wheel – mounted audio and phone controls

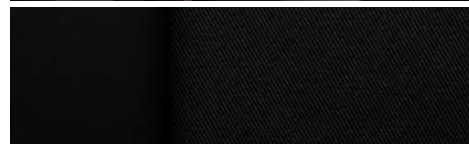

Jet Black Cloth (shown)

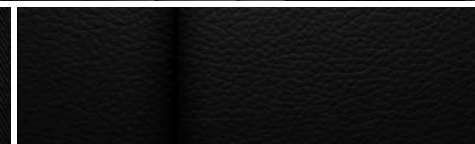

Jet Black Evotex



17" Ultra Silver Metallic-Painted Steel Wheels (RD6)  
Standard on WT

<sup>1</sup> To avoid the risk of injury, never use recovery hooks to tow a vehicle. For more information, see the Recovery Hooks section of your Owner's Manual. <sup>2</sup> Safety or driver assistance features are no substitute for the driver's responsibility to operate the vehicle in a safe manner. Read the vehicle Owner's Manual for important feature limitations and information.

# LT



Summit White



Sterling Gray Metallic



Harvest Bronze Metallic



Radiant Red Tintcoat<sup>1</sup>



Glacier Blue Metallic<sup>1</sup>



Black

<sup>1</sup>Extra-cost color.

# LT



In addition to [standard equipment](#), select LT features include:

## MECHANICAL

Engine – 2.7L Turbo and Automatic Stop/Start with disable switch

Transfer case – single-speed, electronic Autotrac with push-button control (4x4 models)

Transmission – 8-speed automatic, electronically controlled with overdrive

## EXTERIOR

Mirrors – power-adjustable, manual-folding with Cool Anderson Metallic-painted caps

Recovery hooks<sup>1</sup> – Black (4x4 models)

Tires – 255/65R17 all-season

## INTERIOR

Air conditioning – manual, single-zone with rear air vents

Center console – floor-mounted, front compartment with cup holders and cell phone storage

Driver Information Center – 8-inch diagonal fully digital display

HD Rear Vision Camera<sup>2</sup>

Keyless Open and Start

Push-Button Start

Remote Keyless Entry

Seat – driver 6-way manual adjuster

Steering column – manual tilt

Steering wheel – wrapped, with mounted audio and phone controls

Windows – power with driver express-up/-down, all others express-down



Jet Black Cloth

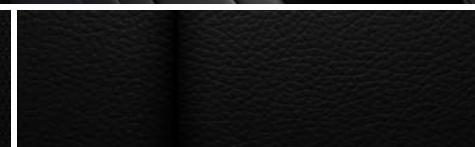

Jet Black Evotex<sup>3</sup> (shown)



17" Argent Metallic Aluminum Wheels (Q5W)  
Standard on LT



18" Android Dark Full-Gloss Aluminum Wheels (PZ1)  
Available on LT

<sup>1</sup> To avoid the risk of injury, never use recovery hooks to tow a vehicle. For more information, see the Recovery Hooks section of your Owner's Manual. <sup>2</sup> Safety or driver assistance features are no substitute for the driver's responsibility to operate the vehicle in a safe manner. Read the vehicle Owner's Manual for important feature limitations and information. <sup>3</sup> Requires available LT Convenience Package III.



# Trail Boss



Summit White



Sterling Gray Metallic



Sand Dune Metallic



Harvest Bronze Metallic



Nitro Yellow Metallic<sup>1</sup>



Radiant Red Tintcoat<sup>1</sup>



Glacier Blue Metallic<sup>1</sup>



Black

<sup>1</sup>Extra-cost color.

# Trail Boss



In addition to [standard equipment](#), select Trail Boss features include:

## MECHANICAL

Differential – automatic locking rear

Engine – 2.7L Turbo Plus and Automatic Stop/Start with disable switch

Suspension – Off-Road with 2-inch factory-installed lift and ultra-wide stance

Transfer case – 2-speed, electronic Autotrac with push-button control; includes Hill Descent Control

Transmission – 8-speed automatic, electronically controlled with overdrive and Tow/Haul mode

## EXTERIOR

Mirrors – power-adjustable, manual-folding with molded-in color Black caps

Recovery hooks<sup>1</sup> – Black

Tires – 265/65R18 all-terrain

## INTERIOR

Air conditioning – manual, single-zone with rear air vents

Center console – floor-mounted, front compartment with cup holders and cell phone storage

Driver Information Center – 8-inch diagonal fully digital display

HD Rear Vision Camera<sup>2</sup>

Push-Button Start

Remote Keyless Entry

Seat – driver 6-way manual adjuster

Steering column – manual tilt

Steering wheel – mounted audio and phone controls

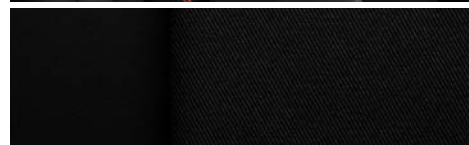

Jet Black Cloth

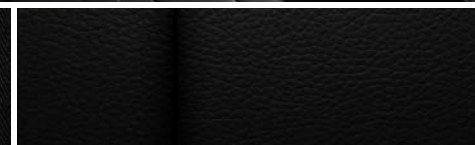

Jet Black Evotex (shown)



18" High-Gloss Black Aluminum Wheels (PZX)  
Standard on Trail Boss



20" High-Gloss Black Aluminum Wheels (NZZ)  
Available on Trail Boss

<sup>1</sup> To avoid the risk of injury, never use recovery hooks to tow a vehicle. For more information, see the Recovery Hooks section of your Owner's Manual. <sup>2</sup> Safety or driver assistance features are no substitute for the driver's responsibility to operate the vehicle in a safe manner. Read the vehicle Owner's Manual for important feature limitations and information.

# Z71



Summit White



Sterling Gray Metallic



Sand Dune Metallic



Harvest Bronze Metallic



Nitro Yellow Metallic<sup>1</sup>



Radiant Red Tintcoat<sup>1</sup>



Glacier Blue Metallic<sup>1</sup>



Black

<sup>1</sup>Extra-cost color.

# Z71



In addition to standard equipment, select Z71 features include:

## MECHANICAL

Differential – automatic locking rear

Engine – 2.7L Turbo Plus and Automatic Stop/Start with disable switch

Hill Descent Control

Transfer case – 2-speed, electronic Autotrac with push-button control

Transmission – 8-speed automatic, electronically controlled with overdrive and Tow/Haul mode

## EXTERIOR

Headlamps, fog lamps and taillamps – LED

Mirrors – heated, power-adjustable, manual-folding with Black-painted caps

Recovery hooks<sup>1</sup> – Red

Tires – 265/65R18 all-terrain

## INTERIOR

Air conditioning – manual, single-zone with rear air vents

Center console – floor-mounted, front compartment with cup holders and cell phone storage

Cruise control – electronic with Set and Resume Speed

Driver Information Center – 8-inch diagonal fully digital display

HD Rear Vision Camera<sup>2</sup>

Keyless Open and Start

Power outlet – 120-volt (up to 400 watts, shared with bed-mounted 120-volt outlet) on rear of center console

Push-Button Start

Seat – driver 6-way manual adjuster

Steering column – manual tilt

Steering wheel – wrapped, with mounted audio and phone controls

Window – manual-sliding rear with defogger

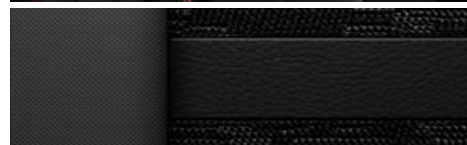

Jet Black/Adrenaline Red Cloth/Evotex



Jet Black/Adrenaline Red Perforated Leather-Appointed Front Seating<sup>3</sup> (shown)



18" Android Dark Full-Gloss Aluminum Wheels (PZI)  
Standard on Z71



20" Dark Android Aluminum Wheels (N2T)  
Available on Z71<sup>4</sup>

<sup>1</sup> To avoid the risk of injury, never use recovery hooks to tow a vehicle. For more information, see the Recovery Hooks section of your Owner's Manual. <sup>2</sup> Safety or driver assistance features are no substitute for the driver's responsibility to operate the vehicle in a safe manner. Read the vehicle Owner's Manual for important feature limitations and information. <sup>3</sup> Requires available Z71 Convenience Package III. <sup>4</sup> Requires available Z71 Convenience Package II or Z71 Convenience Package III.

# ZR2



Summit White



Sterling Gray Metallic



Sand Dune Metallic



Harvest Bronze Metallic



Nitro Yellow Metallic<sup>1</sup>



Radiant Red Tintcoat<sup>1</sup>



Glacier Blue Metallic<sup>1</sup>



Black

<sup>1</sup>Extra-cost color.

# ZR2



In addition to [standard equipment](#), select ZR2 features include:

## MECHANICAL

**ZR2 Off-Road Package** – 3-inch factory-installed lift with high-performance suspension, ultra-wide stance, Multimatic DSSV™ Damping System, off-road front fascia and rear bumper, fender flares and Chevy flowtie grille badge

**Trailering Package** – trailer hitch and 7-pin connector; Trailering App

**Differential** – electronic, full locking front and rear, driver selectable

**Engine** – 2.7L Turbo High-Output and Automatic Stop/Start with disable switch

**Hill Descent Control**

**Transfer case** – 2-speed, electronic Autotrac with push-button control

**Transmission** – 8-speed automatic, electronically controlled with overdrive and Tow/Haul mode

## EXTERIOR

**Bedliner** – spray-on with ZR2 logo

**Headlamps, fog lamps and taillamps** – LED

**Mirrors** – heated, power-adjustable, manual-folding with Black-painted caps

**Recovery hooks<sup>1</sup>** – Red

**Tailgate** – EZ Lift & Lower

– StowFlex with lockable storage compartment

**Tires** – 285/70R17 MT

## INTERIOR

**Air conditioning** – automatic, dual-zone with rear air vents

**Driver Information Center** – 11-inch diagonal fully digital display

**Remote vehicle starter system**

**Seat** – driver 8-way power adjuster with power lumbar control

**Seats** – heated driver and front passenger

**Steering column** – manual tilt/telescoping

**Steering wheel** – wrapped, with mounted audio and phone controls

**Window** – manual-sliding rear with defogger

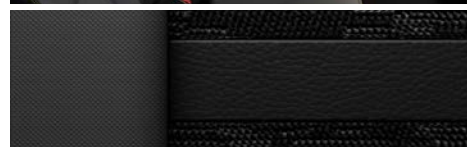

Jet Black/Artemis Cloth/Evotex

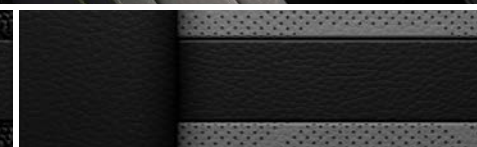

Jet Black/Artemis Perforated Leather-Appointed Front Seating<sup>2</sup> (shown)



17" Graphite and Oxide Gold Aluminum Wheels (R1U) Standard on ZR2



17" Beadlock Capable Wheels with Tech Bronze Decorative Ring (SMY) Available on ZR2 with Desert Boss Special Edition (dealer-installed accessory)

<sup>1</sup> To avoid the risk of injury, never use recovery hooks to tow a vehicle. For more information, see the Recovery Hooks section of your Owner's Manual. <sup>2</sup> Requires available ZR2 Convenience Package III.

# Standard equipment

Standard on every Colorado:

## MECHANICAL

Air filter – engine air filtration monitor

Battery – with rundown protection and retained accessory power

Brakes – 4-wheel antilock disc with Duralife® rotors

Frame – fully boxed

Hitch Guidance<sup>1</sup>

Hitch View<sup>1</sup>

Radiator grille shutters – automatic

StabiliTrak® – Electronic Stability Control System and Traction Control; includes Electronic Trailer Sway Control and Hill Start Assist

Steering – rack-and-pinion, electric power-assisted

Transmission – 8-speed automatic, electronically controlled with overdrive

## EXTERIOR

Bumper – rear CornerSteps (excludes ZR2)

Cargo box light – back of cab

Daytime running lamps

Fuel filler – capless fueling

Glass – solar-absorbing windshield, side windows with solar glazing and deep-tinted rear windows

Headlamps – halogen with automatic on/off with automatic delay; LED on Z71 and ZR2

Moldings – Black beltline

## INTERIOR

Chevy Safety Assist<sup>1</sup>

Automatic Emergency Braking  
Front Pedestrian and Bicyclist Braking  
Lane Keep Assist with Lane Departure Warning  
Forward Collision Alert  
IntelliBeam, auto high beams  
Following Distance Indicator (functionality requires a late available software update; see dealer for details)

Airbags<sup>2</sup> – frontal airbags for driver and front passenger; seat-mounted side-impact airbags for driver and front passenger; head-curtain airbags for front and rear outboard seating positions; includes front Passenger Sensing System for frontal passenger airbag

Audio – 6-speaker system

Buckle to Drive

Connectivity – Bluetooth® phone connectivity and wireless audio streaming<sup>3</sup>

Door locks – power programmable with lockout protection and rear door child security

Driver Information Center – digital

Entertainment – 11.3-inch diagonal LCD color display with Google built-in<sup>4</sup> compatibility, AM/FM stereo, Bluetooth audio streaming<sup>3</sup> for two active devices, wireless Apple CarPlay<sup>®5</sup> and wireless Android Auto<sup>®6</sup> compatibility, voice recognition and available In-Vehicle Apps<sup>7</sup>

HD Rear Vision Camera<sup>1</sup>

Media – two USB ports<sup>8</sup>

Power outlet – 12-volt auxiliary, inside center console

Push-Button Start

Rear Seat Reminder<sup>9</sup>

Seats – front bucket and rear 60/40 split-folding bench with storage

SiriusXM<sup>®10</sup> – 3-month trial subscription to SXM Platinum Plan

Steering wheel – with mounted audio, phone and Driver Information Center controls

Teen Driver technology<sup>1</sup>

Theft-deterrent system – unauthorized entry

Tire Pressure Monitoring System – with Tire Fill Alert (does not apply to spare tire)

Windows – power

<sup>1</sup> Safety or driver assistance features are no substitute for the driver's responsibility to operate the vehicle in a safe manner. Read the vehicle Owner's Manual for important feature limitations and information. <sup>2</sup> A NOTE ON CHILD SAFETY: Always use seat belts and the correct child restraint for your child's age and size, even with airbags. Even in vehicles equipped with the Passenger Sensing System, children are safer when properly secured in a rear seat in the appropriate infant, child or booster seat. Never place a rear-facing infant restraint in the front seat of any vehicle equipped with an active frontal airbag. See your vehicle Owner's Manual and the child safety seat instructions for more safety information. <sup>3</sup> Go to [my.chevrolet.com/learnAbout/bluetooth](http://my.chevrolet.com/learnAbout/bluetooth) to find out which phones are compatible with the vehicle. Full Bluetooth feature functionality varies by device, model and software version. <sup>4</sup> Google built-in services are subject to limitations and availability may vary by vehicle, infotainment system and location. Select service plan required. Certain Google actions and functionality may require account linking. User terms and privacy statements apply. <sup>5</sup> Vehicle user interface is a product of Apple, and its terms and privacy statements apply. Requires compatible iPhone, and data plan rates apply. <sup>6</sup> Vehicle user interface is a product of Google, and its terms and privacy statements apply. Requires the Android Auto app on Google Play and a compatible Android smartphone. Data plan rates apply. You can check which smartphones are compatible at [g.co/androidauto/requirements](http://g.co/androidauto/requirements). <sup>7</sup> Third-party trademarks are the property of their respective third-party owners and used under agreement. Requires active service plan and paid AT&T vehicle data plan. Visit [onstar.com](http://onstar.com) for details and limitations. <sup>8</sup> Not compatible with all devices. <sup>9</sup> Does not detect people or items. Always check rear seat before exiting. <sup>10</sup> If you decide to continue service after your trial, your selected subscription plan will automatically renew thereafter. You will be charged at then-current rates. Fees and taxes apply. To cancel you must call SiriusXM at 1-866-635-2349. See SiriusXM Customer Agreement for complete terms at [siriusxm.com](http://siriusxm.com). All fees and programming subject to change.

● STANDARD ○ AVAILABLE – NOT AVAILABLE

	WT	LT	TRAIL BOSS	Z71	ZR2
<b>SAFETY AND DRIVER ASSISTANCE</b>					
Chevy Safety Assist <sup>1</sup>	●	●	●	●	●
Automatic Emergency Braking	●	●	●	●	●
Front Pedestrian and Bicyclist Braking	●	●	●	●	●
Lane Keep Assist with Lane Departure Warning	●	●	●	●	●
Forward Collision Alert	●	●	●	●	●
IntelliBeam, auto high beams	●	●	●	●	●
Following Distance Indicator (functionality requires a late available software update; see dealer for details)	●	●	●	●	●
Airbags <sup>2</sup> – frontal airbags for driver and front passenger; seat-mounted side-impact airbags for driver and front passenger; head-curtain airbags for front and rear outboard seating positions; includes front Passenger Sensing System for frontal passenger airbag	●	●	●	●	●
Blind Zone Steering Assist <sup>1</sup> (requires available Safety Package)	○	○	○	○	○
Buckle to Drive	●	●	●	●	●
HD Rear Vision Camera <sup>1</sup>	●	●	●	●	●
HD Surround Vision <sup>1</sup> (requires available Technology Package)	○	○	○	○	○
Rear Cross Traffic Braking <sup>1</sup> (requires available Safety Package)	○	○	○	○	○
Rear Park Assist <sup>1</sup> (requires available Safety Package)	○	○	○	○	○
Rear Pedestrian Alert <sup>1</sup> (requires available Technology Package)	○	○	○	○	○
Teen Driver technology <sup>1</sup>	●	●	●	●	●
Theft-deterrent system – unauthorized entry	●	●	●	●	●
Tire Pressure Monitoring System – with Tire Fill Alert (does not monitor spare tire)	●	●	●	●	●
Up to 3 months of OnStar <sup>®</sup> Safety & Security coverage <sup>3</sup>	●	●	●	●	●
<b>MECHANICAL</b>					
Air filter – engine air filtration monitor	●	●	●	●	●
Battery – with rundown protection and retained accessory power	●	●	●	●	●
Brakes – 4-wheel antilock disc with Duralife rotors	●	●	●	●	●
Differential – automatic locking rear	○	○	●	●	–
– electronic, driver-selectable full locking front and rear	–	–	–	–	●

	WT	LT	TRAIL BOSS	Z71	ZR2
<b>MECHANICAL (CONTINUED)</b>					
Engine – 2.7L Turbo equipped with Active Fuel Management and Automatic Stop/Start with disable switch; 237 hp @ 5600 rpm, 260 lb.-ft. of torque @ 1200-4000 rpm	●	●	–	–	–
– 2.7L Turbo Plus equipped with Active Fuel Management and Automatic Stop/Start with disable switch; 310 hp @ 5600 rpm, 391 lb.-ft. of torque @ 2000 rpm	○	○	●	●	–
– 2.7L Turbo High-Output equipped with Active Fuel Management and Automatic Stop/Start with disable switch; 310 hp @ 5600 rpm, 430 lb.-ft. of torque @ 3000 rpm	–	–	–	–	●
– engine block heater (not available on LT 2WD models)	○	○	○	○	○
Engine cover – appearance (requires available 2.7L Turbo Plus engine on WT and LT)	○	○	●	●	●
Frame – fully boxed	●	●	●	●	●
Hill Descent Control	–	–	●	●	●
Hitch Guidance <sup>1</sup>	●	●	●	●	●
Hitch View <sup>1</sup>	●	●	●	●	●
Radiator grille shutters – automatic	●	●	●	●	●
StabiliTrak – Electronic Stability Control System and Traction Control; includes Electronic Trailer Sway Control and Hill Start Assist	●	●	●	●	●
Steering – rack-and-pinion, electric power-assisted	●	●	●	●	●
Suspension – Off-Road with 2-inch factory-installed lift and ultra-wide stance	–	–	●	–	–
ZR2 Off-Road Package – 3-inch factory-installed lift with high-performance suspension, ultra-wide stance, Multimatic DSSV™ Damping System, off-road front fascia and rear bumper, fender flares and Chevy flowtie grille badge	–	–	–	–	●
Trailer brake controller – integrated; included with available Advanced Trailering Package (requires available Trailering Package [except ZR2])	○	○	○	○	●
Transfer case – single-speed, electronic Autotrac with push-button control (4x4 models)	●	●	–	–	–
– 2-speed, electronic Autotrac with push-button control	–	–	●	●	●
– transfer case shield	–	–	●	●	●
Transmission – 8-speed automatic, electronically controlled with overdrive	●	●	●	●	●

<sup>1</sup> Safety or driver assistance features are no substitute for the driver's responsibility to operate the vehicle in a safe manner. Read the vehicle Owner's Manual for important feature limitations and information. <sup>2</sup> A NOTE ON CHILD SAFETY: Always use seat belts and the correct child restraint for your child's age and size, even with airbags. Even in vehicles equipped with the Passenger Sensing System, children are safer when properly secured in a rear seat in the appropriate infant, child or booster seat. Never place a rear-facing infant restraint in the front seat of any vehicle equipped with an active frontal airbag. See your vehicle Owner's Manual and the child safety seat instructions for more safety information. <sup>3</sup> When you select a monthly plan within 15 days of activating your 1-month trial, you'll receive the next 2 months of the plan you select at no additional charge when you associate an approved payment method on file to your account and authorize recurring payments for your service plan. The amount and frequency of each recurring payment is based upon the service(s) and payment interval(s) you select from the options provided. After the trial expires, OnStar will automatically bill your payment method monthly at then-current standard monthly rates. Plans containing 4G LTE data will be billed every 30 days by AT&T. You may cancel at any time by pushing your blue OnStar button or calling 1-888-466-7827. May not be combined with other offers or retroactively applied. Offer subject to change.



● STANDARD ○ AVAILABLE – NOT AVAILABLE

	WT	LT	TRAIL BOSS	Z71	ZR2
<b>EXTERIOR</b>					
Bedliner – Black spray-on with Chevrolet logo on LT, Trail Boss and Z71; ZR2 includes ZR2 logo	○	○	○	○	●
Bumper – rear CornerSteps	●	●	●	●	–
Cameras – underbody <sup>1</sup> ; front and rear views (requires available Bose premium sound system and HD Surround Vision <sup>1</sup> on Z71; requires available HD Surround Vision <sup>1</sup> on ZR2)	–	–	–	○	○
Cargo box light – back of cab	●	●	●	●	●
Daytime running lamps – halogen	●	●	●	–	–
– LED (requires available LT Convenience Package III on LT)	–	○	–	●	●
Door handles – Black	●	–	●	–	–
– body-color	–	●	–	●	●
Fog lamps – LED (requires available LT Convenience Package on LT)	–	○	–	●	●
Fuel filler – capless fueling	●	●	●	●	●
Glass – solar-absorbing windshield	●	●	●	●	●
– deep-tinted behind front doors	●	●	●	●	●
– side windows with solar glazing	●	●	●	●	●
Headlamps – halogen with automatic on/off with automatic delay	●	●	●	–	–
– LED with automatic on/off with automatic delay (requires available LT Convenience Package III on LT)	–	○	–	●	●
Mirrors – power-adjustable, manual-folding	●	●	●	–	–
– heated, power-adjustable, manual-folding (requires available Safety Package on WT and Trail Boss; requires available LT Convenience Package II or Safety Package on LT)	○	○	○	●	●
– molded-in color Black caps	●	–	●	–	–
– Black-painted caps (requires available Safety Package on WT and Trail Boss)	○	–	○	●	●
– Cool Anderson Metallic-painted caps	–	●	–	–	–
Moldings – Black beltline	●	●	●	●	●
– B-pillar appliqué (not available with Harvest Bronze Metallic or Black exterior colors)	–	–	–	●	●
– wheel opening	–	–	●	○	●
Power outlet – 120-volt (up to 400 watts, shared with rear center console-mounted 120-volt outlet), bed-mounted (requires available LT Convenience Package III on LT)	–	○	–	●	●
Recovery hooks <sup>2</sup> – Black (standard on WT and LT 4x4 models)	●	●	●	–	–
– Red	–	–	–	●	●
Rocker panel protector	–	–	–	–	●

	WT	LT	TRAIL BOSS	Z71	ZR2
<b>EXTERIOR (CONTINUED)</b>					
Tailgate – remote locking/unlocking (requires available WT Convenience Package on WT)	○	●	●	●	●
– keyed cylinder lock (requires available WT Convenience Package II or Technology Package on WT; requires available LT Convenience Package on LT; requires available Trail Boss Convenience Package II or Technology Package on Trail Boss; requires available Z71 Convenience Package II on Z71)	○	○	○	○	●
– EZ Lift & Lower (requires available WT Convenience Package II on WT; requires available LT Convenience Package on LT; requires available Trail Boss Convenience Package II on Trail Boss; requires available Z71 Convenience Package II on Z71)	○	○	○	○	●
– StowFlex with lockable storage compartment (requires available WT Convenience Package II on WT; requires available LT Convenience Package on LT; requires available Trail Boss Convenience Package II on Trail Boss; requires available Z71 Convenience Package II on Z71)	○	○	○	○	●
Taillamps – LED (requires available LT Convenience Package III on LT)	–	–	○	●	●
Tire – compact spare, 175/90D18	●	●	–	–	–
– full-size spare, 265/70R17 all-season	–	–	●	●	–
– full-size spare, 285/70R17 (requires available 275/60R20 all-terrain tires on Trail Boss)	–	–	○	–	●
– full-size spare, 255/65R17 all-season	○	○	–	–	–
– full-size spare, 275/60R20 (requires available 275/60R20 all-terrain tires)	–	–	○	–	–
Tires – 255/65R17 all-season	●	●	–	–	–
– 265/65R18 all-terrain	–	–	●	●	–
– 285/70R17 MT	–	–	–	–	●
– 265/60R18 all-season; included with Android dark full-gloss aluminum wheels (PZ1)	–	○	–	–	–
– LT275/65R18C Goodyear Wrangler Territory <sup>®</sup> MT	–	–	○	–	–
– 275/60R20 all-terrain	–	–	○	–	–
– 255/55R20 all-terrain; included with Dark Android aluminum wheels (NZT)	–	–	–	○	–
Wheels – 17" Ultra Silver Metallic-painted steel (RD6)	●	–	–	–	–
– 17" Argent Metallic aluminum (Q5W)	–	●	–	–	–
– 18" high-gloss Black aluminum (PZX)	–	–	●	–	–
– 18" Android dark full-gloss aluminum (PZ1)	–	○	–	●	–
– 17" Graphite and Oxide Gold aluminum (R1U)	–	–	–	–	●
– 17" beadlock capable with Tech Bronze decorative ring (requires and only available with Desert Boss Special Edition) (SMY) (dealer-installed accessory)	–	–	–	–	○
– 20" high-gloss Black aluminum (NZS)	–	–	○	–	–
– 20" Dark Android aluminum (NZT)	–	–	–	○	–

<sup>1</sup> Safety or driver assistance features are no substitute for the driver's responsibility to operate the vehicle in a safe manner. Read the vehicle Owner's Manual for important feature limitations and information. <sup>2</sup> To avoid the risk of injury, never use recovery hooks to tow a vehicle. For more information, see the Recovery Hooks section of your Owner's Manual.

● STANDARD ○ AVAILABLE – NOT AVAILABLE

	WT	LT	TRAIL BOSS	Z71	ZR2
<b>INTERIOR</b>					
Air conditioning – manual, single-zone	●	●	●	●	–
– automatic, dual-zone (requires available LT Convenience Package on LT; requires available Z71 Convenience Package II on Z71)	–	○	–	○	●
Air vents – rear, heating/cooling (requires available floor-mounted center console on WT)	○	●	●	●	●
Armrest – rear center (requires available LT Convenience Package III on LT; requires available Z71 Convenience Package III on Z71; requires available ZR2 Convenience Package III on ZR2)	–	○	–	○	○
Center console – floor-mounted, front compartment with cup holders and cell phone storage; includes rear heating/cooling air vents (requires available 2.7L Turbo Plus engine on WT)	○	●	●	●	●
Cruise control – electronic with Set and Resume Speed (requires available WT Convenience Package on WT; requires available LT Convenience Package on LT; requires available Trail Boss Convenience Package on Trail Boss)	○	○	○	●	●
– Adaptive Cruise Control <sup>1</sup> (requires available Technology Package)	○	○	○	○	○
Defogger – rear-window (requires available WT Convenience Package on WT; requires available LT Convenience Package on LT; requires available Trail Boss Convenience Package on Trail Boss)	○	○	○	●	●
Door locks – power programmable with lockout protection and rear door child security	●	●	●	●	●
Driver Information Center – 8-inch diagonal fully digital display	●	●	●	●	–
– 11-inch diagonal fully digital display	–	–	–	–	●
Floor covering – color-keyed carpeting	●	●	●	●	●
– full-length vinyl	○	–	○	–	–
Floor mats – front and rear, carpeted	–	●	●	●	●
Keyless Open and Start	–	●	–	●	●
Lighting – center dome lamp	●	●	●	●	●
– dual reading lamps	–	●	–	●	●

	WT	LT	TRAIL BOSS	Z71	ZR2
<b>INTERIOR (CONTINUED)</b>					
Mirror – rearview, manual day/night	●	●	●	●	–
– rearview, auto-dimming (requires available LT Convenience Package II on LT; requires available Z71 Convenience Package II on Z71)	–	○	–	○	●
Power outlet – front auxiliary, 12-volt	●	●	●	●	●
– 120-volt (up to 400 watts, shared with bed-mounted 120-volt outlet), on rear of center console (requires available LT Convenience Package III on LT)	–	○	–	●	●
Push-Button Start	●	●	●	●	●
Rear Seat Reminder <sup>2</sup>	●	●	●	●	●
Remote Keyless Entry	●	–	●	–	–
Remote vehicle starter system (requires available LT Convenience Package II on LT; requires available Z71 Convenience Package II on Z71)	–	○	–	○	●
Steering column – manual tilt	●	●	●	●	–
– manual tilt/telescoping (requires available LT Convenience Package on LT; requires available Z71 Convenience Package II on Z71)	–	○	–	○	●
Steering wheel – with mounted audio and phone controls	●	●	●	●	●
– wrapped	–	●	–	●	●
– heated (requires available LT Convenience Package III on LT; requires available Z71 Convenience Package III on Z71; requires available ZR2 Convenience Package III on ZR2)	–	○	–	○	○
Sunroof – power with manual shade (requires available LT Convenience Package II or LT Convenience Package III and 4x4 on LT)	–	○	–	○	○
Visors – driver and front passenger, vanity mirrors	●	●	●	–	–
– driver and front passenger, illuminated vanity mirrors (requires available LT Convenience Package on LT)	–	○	–	●	●
Window – manual-sliding rear with defogger (requires available WT Convenience Package on WT; requires available LT Convenience Package on LT; requires available Trail Boss Convenience Package on Trail Boss)	○	○	○	●	●
Windows – power with express-down, all windows	●	–	–	–	–
– power with driver express-up/-down, all others express-down	–	●	●	●	●
– remote express-down, all windows (requires available 4x4 on LT)	–	○	–	●	●

<sup>1</sup> Safety or driver assistance features are no substitute for the driver's responsibility to operate the vehicle in a safe manner. Read the vehicle Owner's Manual for important feature limitations and information. <sup>2</sup> Does not detect people or items. Always check rear seat before exiting.

● STANDARD ○ AVAILABLE – NOT AVAILABLE

	WT	LT	TRAIL BOSS	Z71	ZR2
<b>SEATING</b>					
Seats – front bucket	●	●	●	●	●
– rear 60/40 split-folding bench with storage	●	●	●	●	●
Seat – driver 6-way manual adjuster	●	●	●	●	–
– driver 8-way power adjuster with power lumbar control (requires available WT Convenience Package II on WT; requires available LT Convenience Package II on LT; requires available Trail Boss Convenience Package II on Trail Boss; requires available Z71 Convenience Package II on Z71)	○	○	○	○	●
– front passenger 4-way manual adjuster	●	●	●	●	●
Heated seats – driver and front passenger (requires available LT Convenience Package II on LT; requires available Z71 Convenience Package II on Z71)	–	○	–	○	●
Ventilated seats – driver and front passenger (requires available Z71 Convenience Package III on Z71; requires available ZR2 Convenience Package III on ZR2)	–	–	–	○	○
Map pockets – driver seatback (requires available LT Convenience Package III on LT; requires available Z71 Convenience Package III on Z71; requires available ZR2 Convenience Package III on ZR2)	–	○	–	○	○
– front passenger seatback	–	●	–	●	●
Memory settings – recalls two presets for power driver seat and exterior mirrors (requires available Z71 Convenience Package III on Z71; requires available ZR2 Convenience Package III on ZR2)	–	–	–	○	○
Seat belts – Black	●	●	●	●	●
– Red	–	–	–	○	–
– Yellow	–	–	–	–	○

	WT	LT	TRAIL BOSS	Z71	ZR2
<b>ENTERTAINMENT</b>					
11.3-inch diagonal advanced color infotainment <sup>1</sup> LCD touch-screen display with Google built-in <sup>2</sup> ; provides navigation capability, connected apps, personalized profiles for each driver's settings, natural voice recognition and phone integration for wireless Apple CarPlay <sup>3</sup> and wireless Android Auto <sup>™4</sup> compatibility	●	●	●	●	●
Audio system – 6-speaker	●	●	●	●	●
– Bose premium 7-speaker sound system (requires available Safety Package and LT Convenience Package II or LT Convenience Package III on LT; requires available Safety Package and Z71 Convenience Package II or Z71 Convenience Package III on Z71; requires available Safety Package on ZR2)	–	○	–	○	○
Media – two USB ports <sup>1</sup> on instrument panel	●	●	●	●	●
– single USB port, <sup>1</sup> charge-only, on rear of front center floor console	–	●	–	–	–
– two USB ports, <sup>1</sup> charge-only, on rear of front center floor console	–	○	–	●	●
SiriusXM <sup>®5</sup> – 3-month trial subscription to SXM Platinum Plan	●	●	●	●	●
Available Wi-Fi <sup>®</sup> Hotspot <sup>6</sup> for up to seven devices, includes 1-month Unlimited Data Plan	○	○	○	○	○
Chevrolet Connected Access <sup>7</sup> with 10 years of standard connectivity, which currently enables features such as Vehicle Diagnostics and Dealer Maintenance Notification	●	●	●	●	●
Wireless Apple CarPlay <sup>3</sup> and wireless Android Auto <sup>4</sup> compatibility	●	●	●	●	●
Wireless charging <sup>8</sup> (requires available LT Convenience Package II on LT; requires available Z71 Convenience Package II on Z71; requires available ZR2 Convenience Package III on ZR2)	–	○	–	○	○

<sup>1</sup> Not compatible with all devices. <sup>2</sup> Google built-in services are subject to limitations and availability may vary by vehicle, infotainment system and location. Select service plan required. Certain Google actions and functionality may require account linking. User terms and privacy statements apply. <sup>3</sup> Vehicle user interface is a product of Apple, and its terms and privacy statements apply. Requires compatible iPhone, and data plan rates apply. <sup>4</sup> Vehicle user interface is a product of Google, and its terms and privacy statements apply. Requires the Android Auto app on Google Play and a compatible Android smartphone. Data plan rates apply. You can check which smartphones are compatible at [g.co/androidauto/requirements](http://g.co/androidauto/requirements). <sup>5</sup> If you decide to continue service after your trial, your selected subscription plan will automatically renew thereafter. You will be charged at then-current rates. Fees and taxes apply. To cancel you must call SiriusXM at 1-866-635-2349. See SiriusXM Customer Agreement for complete terms at [siriusxm.com](http://siriusxm.com). All fees and programming subject to change. <sup>6</sup> Service varies with conditions and location. Requires active service and paid AT&T data plan. Visit [onstar.com](http://onstar.com) for details and limitations. Availability subject to change. <sup>7</sup> Standard connectivity available only to original purchaser for up to 10 years. Connected Access services are subject to change. Does not include emergency or security services. Diagnostic capabilities vary by model and service plan. Message and data rates may apply. Requires contact method on file and enrollment to receive alerts. Not all issues will deliver alerts. Visit [onstar.com](http://onstar.com) for details and limitations. <sup>8</sup> The system wirelessly charges one compatible mobile device. Some phones have built-in wireless charging technology and others require a special adaptor/back cover. To check for phone or other device compatibility, see [my.chevrolet.com/learn](http://my.chevrolet.com/learn) or consult your carrier.

# Available packages

● STANDARD ○ AVAILABLE – NOT AVAILABLE

	WT	LT	TRAIL BOSS	Z71	ZR2
<b>MECHANICAL</b>					
<b>Advanced Trailering Package</b>	○	○	○	○	–
Trailering Package and Trailering App; includes automatic locking rear differential on WT and LT					
<b>Trailering Package</b>	○	○	○	○	●
Heavy-duty, includes trailer hitch and 7-pin connector; includes integrated trailer brake controller on WT and LT (requires available 2.7L Turbo Plus engine and 220-amp generator on WT and LT; requires available 220-amp generator and Advanced Trailering Package on Trail Boss and Z71)					
<b>Desert Boss Special Edition</b>	–	–	–	–	○
Wiring harness kit, Black nameplates, bed-mounted sport bar with ZR2 sail panel, off-road front bumper with safari bar, 17" beadlock-capable wheels, 40" roof off-road light bar, underbody cameras, Front Fender Decal Package, Bodyside Decal Package, Tailgate Decal Package, rear side decal and auxiliary power box					
<b>INTERIOR</b>					
<b>Safety Package</b>	○	○	○	○	○
Blind Zone Steering Assist <sup>1</sup> , Rear Cross Traffic Braking <sup>1</sup> and Rear Park Assist <sup>1</sup> ; includes heated power-adjustable mirrors on WT, LT and Trail Boss (requires available WT Convenience Package on WT; requires available LT Convenience Package on LT; requires available Trail Boss Convenience Package or Trail Boss Convenience Package II on Trail Boss)					
<b>Technology Package</b>	○	○	○	○	○
Adaptive Cruise Control <sup>1</sup> , Rear Pedestrian Alert <sup>1</sup> and HD Surround Vision <sup>1</sup> ; includes tailgate keyed cylinder lock on WT and Trail Boss (requires available Safety Package and WT Convenience Package II on WT; requires available Bose premium 7-speaker sound system, Safety Package and LT Convenience Package II or Bose premium 7-speaker sound system and LT Convenience Package III on LT; requires available Safety Package and Trail Boss Convenience Package II on Trail Boss; requires available Bose premium 7-speaker sound system, Safety Package and Z71 Convenience Package II or Bose premium 7-speaker sound system and Z71 Convenience Package III on Z71; requires available Safety Package on ZR2)					
<b>WT Convenience Package</b>	○	–	–	–	–
Manual-sliding rear window with defogger, cruise control and remote locking/unlocking tailgate					
<b>WT Convenience Package II</b>	○	–	–	–	–
8-way power driver seat adjuster with power lumbar control, EZ Lift & Lower tailgate, StowFlex Tailgate with lockable storage compartment and tailgate keyed cylinder lock (requires available WT Convenience Package)					

	WT	LT	TRAIL BOSS	Z71	ZR2
<b>INTERIOR (CONTINUED)</b>					
<b>LT Convenience Package</b>	–	○	–	–	–
Dual-zone automatic climate control, manual tilt/telescoping steering column, cruise control, illuminated visor vanity mirrors, manual-sliding rear window with defogger, EZ Lift & Lower tailgate, StowFlex Tailgate with lockable storage compartment, tailgate keyed cylinder lock and LED fog lamps					
<b>LT Convenience Package II</b>	–	○	–	–	–
2.7L Turbo Plus engine, 8-way power driver seat adjuster with power lumbar control, heated driver and front passenger seats, remote vehicle starter system, auto-dimming interior rearview mirror, wireless charging <sup>2</sup> ; heated power-adjustable exterior mirrors and 255/65R17 all-season full-size spare tire (requires available LT Convenience Package)					
<b>LT Convenience Package III</b>	–	○	–	–	–
Safety Package, Evotex seating, driver seatback map pocket, rear center armrest, two charge-only USB ports <sup>3</sup> on rear of front center floor console, heated steering wheel, LED headlamps, LED daytime running lamps, LED taillamps, 18" Android dark full-gloss aluminum wheels (PZ1) and 120-volt bed- and rear center console-mounted power outlets (400 watts shared) (requires available LT Convenience Package II)					
<b>Trail Boss Convenience Package</b>	–	–	○	–	–
Manual-sliding rear window with defogger, cruise control and remote locking/unlocking tailgate					
<b>Trail Boss Convenience Package II</b>	–	–	○	–	–
8-way power driver seat adjuster with power lumbar control, EZ Lift & Lower tailgate, StowFlex Tailgate with lockable storage compartment and tailgate keyed cylinder lock (requires available Trail Boss Convenience Package)					
<b>Z71 Convenience Package II</b>	–	–	–	○	–
Dual-zone automatic climate control, manual tilt/telescoping steering column, 8-way power driver seat adjuster with power lumbar control, heated driver and front passenger seats, remote vehicle starter system, auto-dimming interior rearview mirror, wireless charging <sup>2</sup> ; EZ Lift & Lower tailgate, StowFlex Tailgate with lockable storage compartment and tailgate keyed cylinder lock					
<b>Z71 Convenience Package III</b>	–	–	–	○	–
Safety Package, perforated leather-appointed front seating, ventilated front seats, driver seatback map pocket, rear center armrest, driver memory settings and heated steering wheel (requires available Z71 Convenience Package II)					
<b>ZR2 Convenience Package III</b>	–	–	–	–	○
Safety Package, perforated leather-appointed front seating, ventilated front seats, driver seatback map pocket, rear center armrest, driver memory settings, heated steering wheel and wireless charging <sup>2</sup>					

<sup>1</sup> Safety or driver assistance features are no substitute for the driver's responsibility to operate the vehicle in a safe manner. Read the vehicle Owner's Manual for important feature limitations and information. <sup>2</sup> The system wirelessly charges one compatible mobile device. Some phones have built-in wireless charging technology and others require a special adaptor/back cover. To check for phone or other device compatibility, see my.chevrolet.com/learn or consult your carrier. <sup>3</sup> Not compatible with all devices.

## MAXIMUM CAPACITIES

Fuel tank (approximate)	21.4 gallons
Seating (front/rear)	2/3
Cargo volume <sup>1</sup>	41.9 cu. ft.

## PAYLOAD<sup>2</sup>

	2WD	4x4
2.7L Turbo	1,500 lbs. - WT	1,490 lbs. - WT
2.7L Turbo	1,460 lbs. - LT	1,450 lbs. - LT
2.7L Turbo Plus	1,710 lbs. - WT	1,710 lbs. - WT
2.7L Turbo Plus	1,680 lbs. - LT	1,670 lbs. - LT
2.7L Turbo Plus	-	1,580 lbs. - Trail Boss
2.7L Turbo Plus	-	1,580 lbs. - Z71
2.7L Turbo High-Output	-	1,280 lbs. - ZR2

## DIMENSIONS

<b>A</b> - Front track	62.8" - WT and LT 66.1" - Trail Boss 62.6" - Z71 66.3" - ZR2
Rear track	62.8" - WT and LT 66.1" - Trail Boss 62.6" - Z71 66.3" - ZR2
<b>B</b> - Width	74.9" - WT and LT 76.3" - Trail Boss 74.9" - Z71 76.3" - ZR2
<b>C</b> - Height	78.8" - WT and LT 79.9" - Trail Boss 79.6" - Z71 81.8" - ZR2
Ground clearance	7.9" - WT and LT 9.5" - Trail Boss 8.9" - Z71 10.7" - ZR2

<b>D</b> - Wheelbase	131.4" - all models
<b>E</b> - Length	213.0" - WT and LT 213.2" - Trail Boss 213.0" - Z71 212.7" - ZR2
Inside width between wheelhousings	45.4" - all models
Inside bed length at floor	61.7" - all models
Bed width wall to wall	58.2" - WT and LT 58.9" - Trail Boss 58.2" - Z71 58.9" - ZR2
Head room without sunroof (front/rear)	40.3"/38.3" - all models
Leg room (front/rear)	45.2"/34.7" - all models
Shoulder room (front/rear)	57.4"/56.1" - WT and LT 57.4"/56.3" - Trail Boss 57.4"/56.1" - Z71 57.4"/56.3" - ZR2
Hip room (front/rear)	54.7"/53.1" - all models

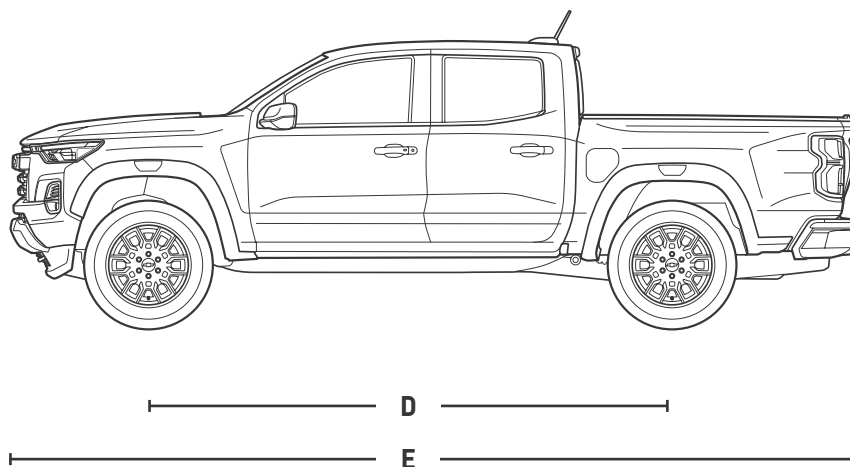
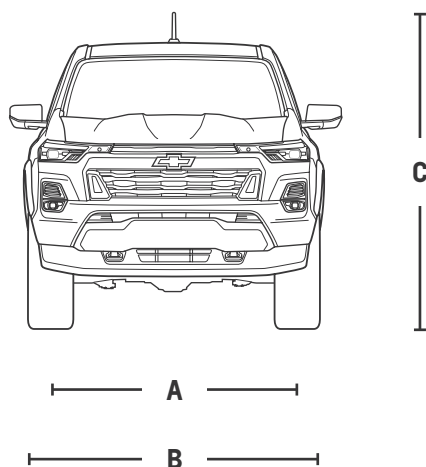

<sup>1</sup> Cargo and load capacity limited by weight and distribution. <sup>2</sup> These maximum payload ratings are intended for comparison purposes only. Before you buy a vehicle or use it to haul people or cargo, carefully review the Vehicle Loading section of the Owner's Manual and check the carrying capacity of your specific vehicle on the label on the inside of the driver door jamb.



Premium All-Weather Floor Liners in Jet Black with Chrome Bowtie Logo available from Chevrolet Accessories.



Sport Bar Package Compatible with Soft Roll-Up Tonneau Cover available from Chevrolet Accessories.



Black Rectangular Assist Steps available from Chevrolet Accessories.



Front Off-Road Auxiliary Lights available from Chevrolet Accessories.



## Important information.

You may be discovering Chevrolet through a personalized online shopping experience or enjoying every year of vehicle ownership. Either way, we're committed to providing the tools and programs you need to help you get the most out of your journey.

### Build & Price >

Create your perfect Chevrolet from start to finish.

### Chevy MyWay<sup>1</sup> >

Engage in a real-time virtual video experience with a Chevy product specialist.

### Chevrolet Complete Care >

Enjoy an owner benefit program that provides excellent service and support from day one.

### My Chevrolet Rewards<sup>2</sup> >

Unlock a world of appreciation that's all about you and your Chevrolet. Start earning and redeeming today.

### Chevy Truck Legends >

Honoring our dependable, long-lasting trucks and the people who keep them going strong.

### Limited Warranty Coverage >

Discover all the ways Chevrolet is committed to providing an excellent ownership experience.



GM, the GM logo, Chevrolet, the Chevrolet logo, and the slogans, emblems, vehicle model names, vehicle body designs and other marks appearing in this brochure are the trademarks and/or service marks of General Motors, its subsidiaries, affiliates or licensors. ©2023 OnStar LLC. All rights reserved. Sirius, XM, SiriusXM and all related marks and logos are trademarks of Sirius XM Radio Inc. Goodyear and Wrangler Territory are registered trademarks of The Goodyear Tire & Rubber Company. The Bluetooth word mark is a registered trademark owned by Bluetooth SIG, Inc., and any use of such mark by Chevrolet is under license. Bose is a registered trademark of the Bose Corp.

©2023 General Motors. All rights reserved. April 2023

FIND NEW ROADS™

CHEVROLET.COM

<sup>1</sup> Chevy MyWay is available to anyone over 18 in the United States to access and experience via [chevrolet.com/myway](https://chevrolet.com/myway). <sup>2</sup> Must be 18 years or older. Points may be earned and redeemed only at GM entities, My Chevrolet Rewards participating dealers or third party retailers in the United States (excluding Puerto Rico, the U.S. Virgin Islands or Guam). Points are not earned on taxes, fees or body shop repair orders and expire without further notice upon Member Account deactivation. Visit [myChevroletrewards.com](https://myChevroletrewards.com) to view My GM Rewards Terms & Conditions.